

Operating and assembly manual

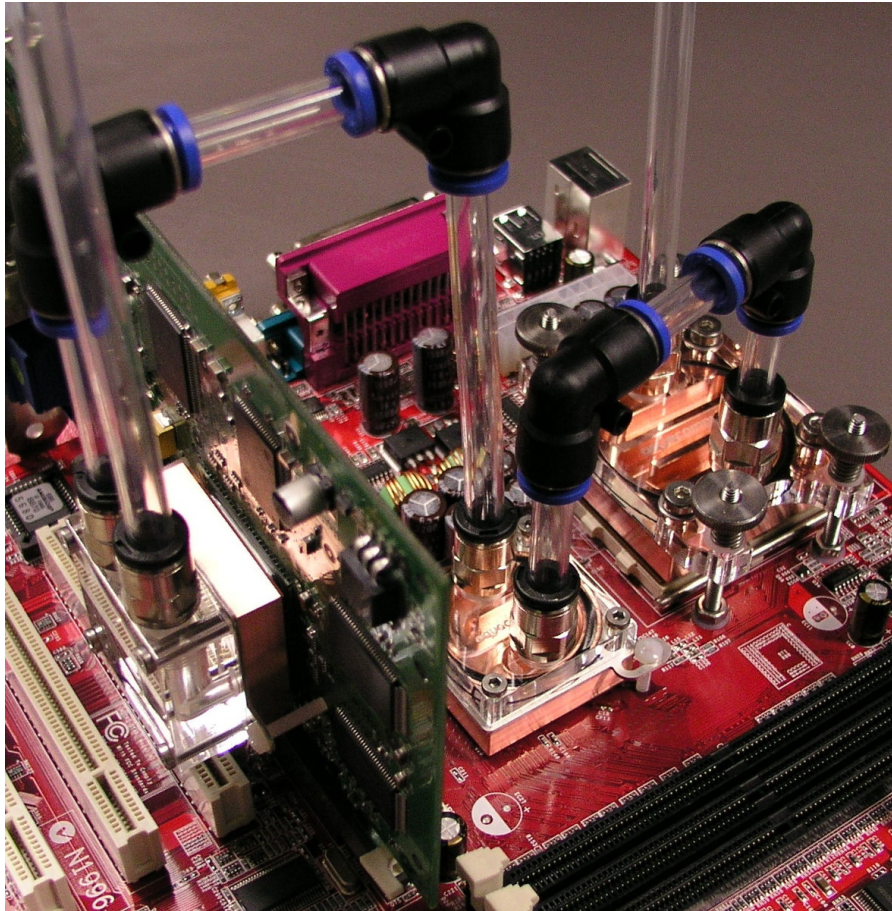

cuplex™ twinplex™
airplex™

and Eheim pumps in sets by Aqua Computer

As of April 2004

Table of contents

1. Introduction	4
2. Safety advices	8
3. Arranging the elements of the cooling system	9
4. Use of the plug&cool connectors.....	10
5. Installation of the CPU-cooler cuplex™, evo and PRO	12
5.1. Preparing the installation of the CPU-cooler.....	12
5.2. Installation with "3-nose-mounting kit"	13
5.3. Installation with "four-hole-mounting kit"	14
5.4. A64-mounting kit of the cuplex and cuplex evo	15
5.5. Combi-mounting kit four-hole and A64	16
5.6. Examination and connection to the cooling system	16
5.7. Proper connection of the cuplex PRO	17
6. Thermo Control System (TCS)	17
7. Installation of the chipset cooler twinplex™ for Northbridge or GPU	18
7.1. Versions with a stainless steel mounting plate	18
7.2. Twinplex for chipsets Intel® i845/i850/i875/E7205 and nForce®..	19
7.3. Twinplex for Radeon® 9500 - 9800XT	19
7.4. Examination and connection to the cooling system	20
8. Installation of the harddrive coolers aquadrive™, aquadrive LT and aquadrive micro	20
8.1. aquadrive.....	20
8.2. aquadrive LT.....	21
8.3. aquadrive micro.....	21
8.4. Examination and connection to the cooling system	21
9. Installation of the water cooled power supply units	21
9.1. CoolCurrent	21
10. Installation of the radiator airplex evo 120/240/360	22
10.1. Installation of the connectors	22
10.2. External mounting kit	22
10.3. Internal installation with fitted mounting plate	23
10.4. Internal installation with CS-fitted mounting plate for airplex evo 120.	23
10.5. Connection to the cooling system	24
10.6. Use of the docking module for the airplex evo.....	24

11. Installation of the pumps	24
11.1 Installation of the pumps Eheim 1046 and 1048	24
11.2. Installation of the pump Hydor.....	25
12. Installation of a water reservoir	26
12.1. Water reservoir of the type aquatube.....	26
12.2. Water reservoir of the type aquainlet	27
13. Putting the system into operation	29
14. Maintenance and care instructions	30

1. Introduction

Dear Customer,

We congratulate you on the purchase of a water cooling system made by May & Wille, Aqua Computer Systeme GbR. We are one of the oldest manufacturers of PC-cooling systems in Germany. Parts manufactured by us meet highest quality standards. During the development we especially took into account that our cooling system is dependable and leak proof. We hope you will enjoy your new cooling system.

To begin with, we would like to give you a short overlook over the system you purchased. We start with **the processor cooler cuplex™** respectively **cuplex evo™** or **cuplex PRO™**.

To enable cooling by water in sensible electronic devices, one basic requirement has to be fulfilled: the entire system has to be completely watertight and long lasting. This had absolute priority in developing the cuplex and cuplex evo. Therefore high-quality plug-connectors are used for our plug&cool-system. These rather expensive, but by the industry almost exclusively used push-in connectors possess a pressure resistance of more than 10 bar, when using suitable hoses, guaranteed by the manufacturer. This pressure is not even closely reached in our systems.

The water cooler models cuplex und cuplex PRO have an acrylic glass lid, which allows for cleaning after long usage. It also enables an optical control of the cooler and the water flow. No part is glued or soldered on the entire cooler, which makes it easy to dismantle. Therefore replacement of individual parts is possible as well as the fitting of new mounting plates e.g. when exchanging the CPU-type.

The high-quality rubber gasket is long lasting. Should it ever wear out, it can easily be replaced. Accessories can be obtained from us. Generally the gaskets should be replaced after 5 years or earlier if the cooler is frequently dismantled. The threaded hose-connections of the plug&cool-system are made watertight with real rubber gaskets. They can be replaced later the same way as the main gaskets of the coolers. The optional available barb connectors and 10/8 connectors are also made watertight with a rubber gasket.

To optimally carry off the heat of the CPU the cooler was made out of copper. The copper used is of very high purity, which results in an outstanding heat conductivity. The cooler is plan-milled, resmoothing is entirely unnecessary.

The coolers cuplex and cuplex PRO, despite their similar looks, pursue two entirely different principles.

Cuplex is built as a classical canal-cooler. It profits especially from an optimized heat transmission in the cooler, to take most advantage of the canal surface. Therefore in construction of the cooler a minimal ground thickness of 4 mm was implemented.

Cuplex PRO however is built as a so-called nozzle-cooler. The water is accelerated by a nozzle-plate which is integrated in the cooler and "sprayed" on the copper surface. This is supported by a very flat construction of the copper surface, which has a thickness of just 4 mm. Due to this construction the cooling performance of cuplex PRO is plainly better than canal- or core-coolers.

Cuplex evo, a so-called core-cooler, pursues a slightly different concept. The cooling medium is led around the massive copper core in six narrow canals. The patented high-grade stainless steel valve guarantees the optimal usage of the cooling surface and therefore an optimal cooling performance, which is on an even higher level than that of the cuplex. With the cuplex evo fitting of new mounting kits when changing the CPU-type is possible without any problems. Without dismantling the actual cooler the corresponding brushed stainless steel mounting plate is slid over the core.

Over time the copper material will develop a protective oxide layer. This protects the copper from further oxidation and has no influence on the function of the cooler.

We follow the path of the water and reach the **Radiator airplex™ evo**. To meet the numerous requirements and the different amounts of space in a variety of systems, the airplex evo is available in different sizes and

connection versions. Generally one can assume that systems with an airplex evo 120 mostly need one fan mounted to the radiator. With the larger versions airplex evo 240, 360 and 1800, depending on the system temperature aimed for and the amount of heat to carry off, often operation without fans, a so-called passive operation of the radiator, is possible. To allow for passive cooling by natural airflow, the radiator should be mounted or set up outside of the computer. A matching external mounting kit made of high-grade brushed stainless steel can be bought from us.

On our journey we now arrive at the driving force of the system: **the pump.**

The pump is one of the most important parts of the system. If it stops working, the processor will soon overheat extremely. As well as a failure of the fan in air-cooled computers, this can result in the destruction of the computer (or even a fire). Therefore a powerful and dependable pump is essential.

The pumps made by Eheim, which are used in the sets of higher quality, distinguish themselves by an almost non-audible working sound and high dependability. These pumps have a ceramic bearing and are built for permanent operation. Added to this the pumps are very common which offers the opportunity to get each component part as a spare part. As a low-priced and good alternative a pump made by Hydor is used in the entry-set. This pump also distinguishes itself with a very long lifespan.

The cycle of the water closes again at our water cooler and we hope to have given you a short insight into our new cooling system. Of course there are many extension possibilities which we will deal with on the following pages and which are included already in some of the sets. The foregoing description just shows the minimal configuration of cooler, radiator and pump, which is necessary to understand the operation of the water cooling system. If you should have any more questions, we would kindly ask you to have a look on our website www.aquacomputer.de at the "FAQ" and in our "Forum". If you can't find an answer to your question there, please send an e-mail to support@aquacomputer.de.

In the course of further technical development our products can be subject to change anytime. Therefore it is possible that the product you purchased doesn't answer exactly the descriptions or the pictures in this manual.

Your aqua-computer team

2. Safety precautions

Before we deal with the system in detail, we would like to give you some safety precautions which have to be observed.

1. Read this manual thoroughly and entirely!
2. Save your data before working on your hardware in any case!
3. Be careful in removing existing conventional cooling devices. Especially when removing cooling devices that are glued on, there is a risk of damaging the hardware!
4. Depending on the individual design of the cooling system it could be necessary to pass hoses through the side of the case. In this case you should use the hose protectors we offer or prevent otherwise that the hoses will be damaged, especially by sharp-edged drilling holes!
5. Do not start your computer before you are absolutely sure that no water escapes your system!
6. Pay attention to the care instructions at the end of this manual. Specially avoid any contact of the Plexiglas components with solvents!
7. Make sure that your wall socket is protected by an FI-fuse and the pump used is suitable for diving operation!
8. Maintain a minimum distance of 0.5 m between the pump and devices that could react in a sensible way to magnetic or electromagnetic fields, or use our separately offered shield-case!

9. Make sure that the computer can not be operated when the pump is switched off. Use a multiple socket with a switch for example, via which you connect pump AND computer with the power supply system!

10. During operation of the computer constantly observe the temperature of the processor. Use software or hardware with a warning- or switch-off-feature for this purpose, since a failure of the cooling system is not audible. Should the temperature of the processor exceed 65°C (149°F) turn off the computer immediately! Optimal for the observation of a water cooling system is the aquaero™, which we developed and which can be purchased separately. Another suitable product is the "Thermo Control System" we offer. Some examples of software can be found on our website at the „Download“-area. We can not accept any liability for damages caused by failure or insufficient performance of the cooling system if this instruction is not followed.

11. Use only the coolant we specify. Other coolants can damage the system and cause leaking or decreased cooling performance.

12. Regularly check the whole system on leaks and replace all seals with signs of wear, every five years at the latest. Suitable spare parts can be purchased from us.

3. Arranging the elements of the cooling system

On arranging the elements of the cooling system you should observe the following essential points:

- All elements have to be flown through sequentially one after the other. A parallel assembly must not be carried out, since the allocation of the water in the different hoses can hardly be predicted and single components could possibly not sufficiently or not at all be cooled.
- The components can be in any order you like. This has (almost) no influence on the cooling performance. In addition to that it is worth mentioning, that the difference in temperature of the

coolant between in- and outgoing line of the radiator is about 1-2 °C in an average system, meaning that the water just heats up about 1-2 °C while flowing through all the coolers.

- A complete cooling circle consists of one water-cooler (e.g. cuplex), one pump and one radiator (e.g. airplex evo) at the minimum.

4. Use of the plug&cool connectors

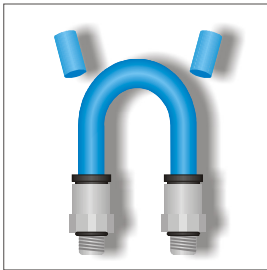

Our plug&cool connection system makes a secure fitting of the hoses possible without any tools. It is pressure and temperature resistant. Please observe the following instructions for the fitting:

1. Cleanly cut the hose to the desired length.

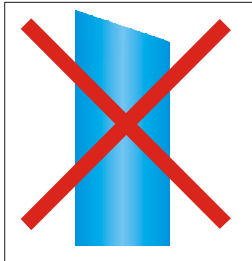

The hose should be cut **evenly** and cleanly **avoiding burs** with a sharp knife or a hose cutter (available in our shop). After each detachment of the hose from a connector the first two centimetres have to be cut off to guarantee a secure operation.

2. Insert the hose into the connector up to the limit stop.

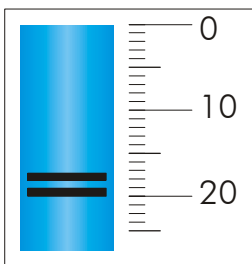

When inserting the hose a first limit stop will be felt which has to be overcome with some effort. If you want to be on the safer side you can mark the hose with a felt pen up to where you have to insert it. Depending on the connector it will be between 18 and 20 mm.

If the hose has to be detached please do the following:

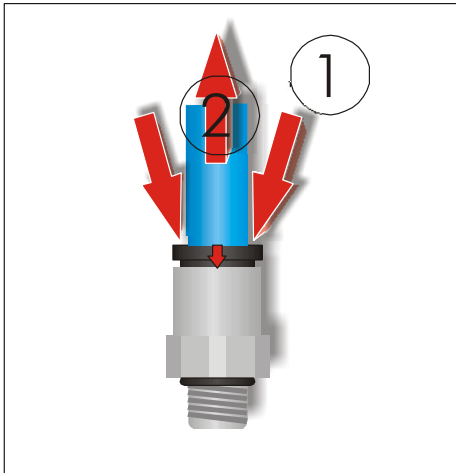

1. Push down the black or blue plastic ring on the connector. For this purpose you can also use the separately available AC Multi-Tool. Slip it over the hose with the middle opening.
2. **While pushing down** pull the hose from the connector.

It is important to remove the length of hose which had been inserted into a connector before connecting the hose again.

It must not be scratched to secure a perfect sealing of the connector.

Now a few remarks about our hose. The hose we use is made of polyurethane. It has an outer diameter of 8 mm and an inner diameter of 6 mm. It makes bending radiuses of less than 10 cm possible and is resistant against many chemicals. A great advantage of the system is that it seals the hose on the outside. This allows the use of the complete diameter, unlike the use of hose barbs which are inserted into the hose and therefore have to have a smaller inner diameter than the hose. With a cross-section area of about 30 mm² the system allows a sufficient flow even in larger lengths of hose.

5. Installation of the CPU-cooler cuplex™, evo and PRO

5.1. Preparing the installation of the CPU-cooler

Now that you understood how the connection system works, you can begin installing the CPU-cooler.

As before any work you do on your computer, you should **save your data** beforehand. Then disconnect your computer from the power supply. To protect the sensible hardware you should ground yourself before installation to avoid electrostatic destruction of the component parts. For that purpose you can use a non-isolated water pipe for example.

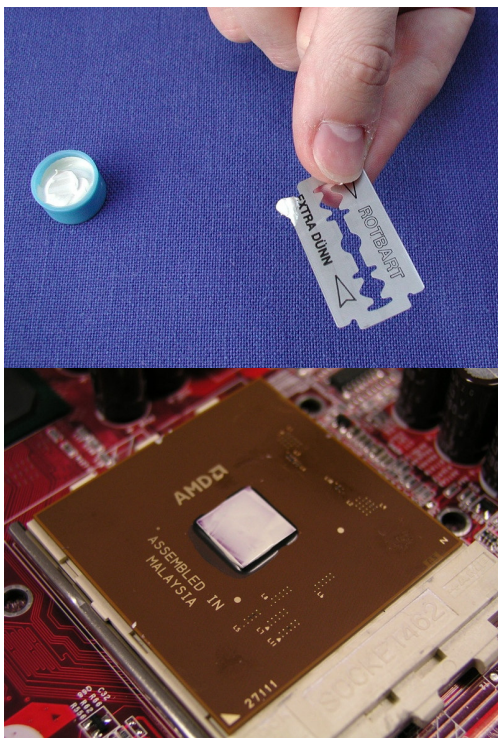

If you change over an existing system you have to remove the old air-cooler from the processor first. For that purpose please read the manual of your air-cooler or your mainboard. After removing the air-cooler you have to clean the core of the processor of any residue of old heat-conductive paste. Then take a razorblade or a plastic spatula and apply a **thin** layer of our supplied heat-conductive paste. The core of the processor, also called "Die", should now be coated by a homogeneous white layer. **Make sure that no heat-conductive paste will get on any other place and remove it if necessary!**

WARNING: If the cooler gets stuck on the surface of the die it can cause an edge of the die to break off. This results in an unrecoverable destruction of the processor. Avoid the cooler to get stuck under any condition. Even so-called spacers do not offer absolute protection. If you are not confident in doing this yourself, please ask a dealer to do it for you.

The principle of installation depends entirely on the kind of fastening of the cooler. That is why we confine the illustration of the installation in-

structions mainly on description of a classic cuplex on a socket A main-board. From this description the procedure for any combination of cooler and fastening version can be derived.

5.2. Installation with "3-nose-mounting kit"

For this fastening version two laser-processed high-grade brushed steel sheets and four pressure-springs are supplied with the cuplex. First slide the brushed high-grade stainless steel sheets through the slits in the Plexiglas lid from the bottom. One of the two brushed high-grade stainless steel sheets only fits through the slit on one side of the Plexiglas lid, therefore confusion is impossible. The slightly differing spring displacements on both sides cause the pressure to finally concentrate on the processor core ("balanced load").

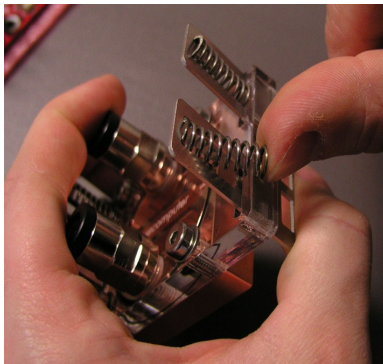
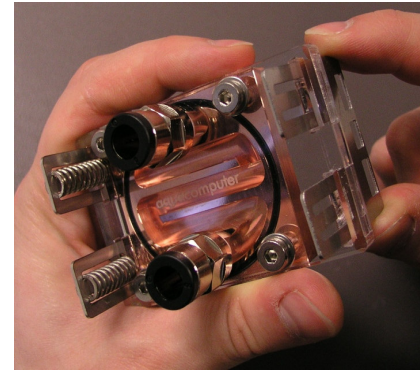

Now insert the pressure springs into the metal sheets above the lid, as shown on the picture. The cooler can be mounted onto the core of the processor now, which should already be prepared with heat-conductive paste as described above.

Make sure that the core of the processor is located centrally below the copper bottom of the cooler and that the longer part of the Plexiglas

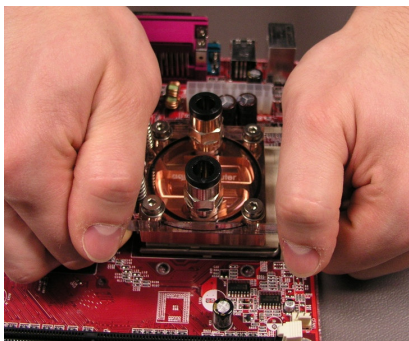
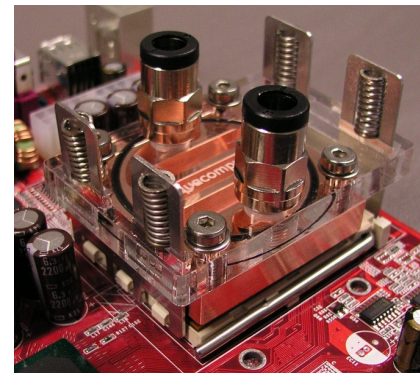

lid which sticks out is situated above the detachment mechanism of the socket. To avoid damage to the core the pressure for mounting has to be applied exactly perpendicular to the surface of the core. Compress the springs putting the thumb balls on the stainless steel sheets from above and taking hold of the lid from below and hook the stainless steel sheets

under the plastic noses of the socket. Avoid the cooler to get stuck, since this will risk a corner of the die to break off. Do not hook in one side after the other!

5.3. Installation with “four-hole-mounting kit”

With the so-called four-hole-mounting kit the cuplex is fixed directly on the circuit board of the motherboard with four screws and pressure springs which are used as screw springs. Therefore you have to fasten

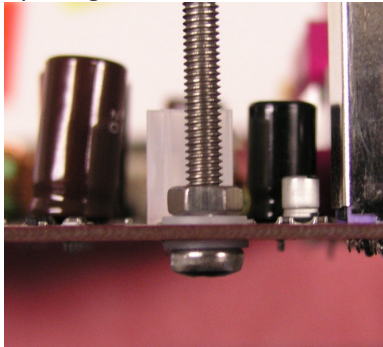

the four screws first. For that purpose detach your motherboard from the computer case. In P4- und Xeon-systems the mostly black plastic mounting for air-coolers has to be removed from the motherboard to reveal the necessary drill holes on it. Next slide a plastic washer over one of the supplied stainless steel M4 screws which you then put through the holes adjacent

to the socket from below. Slide another plastic washer over the screw from above the motherboard and then screw on one of the supplied stainless steel M4 nuts up to the limit by hand. The screw should now be fixed to the board like a standing bolt. Do the same with the three other screws. Now the cuplex can carefully and slowly be put onto the standing bolts. Slowly slide it down until it rests on the prepared core of the processor, without getting it stuck.

To protect the Plexiglas of the cuplex from getting scratched slide another washer over each screw. Now put one of the supplied springs over each of the standing bolts.

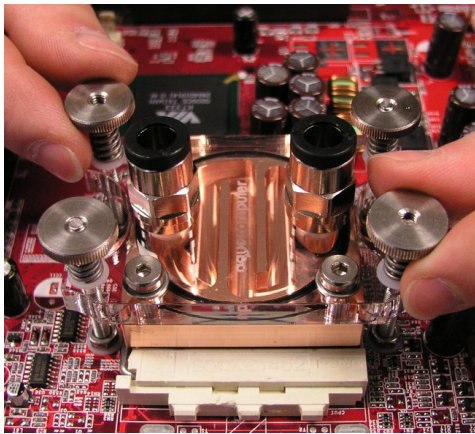

Screw one of the supplied knurled nuts on each screw about 2 turns, so it just grips. For fastening the springs, take turns in fastening two knurled nuts at a time placed opposite of each other diagonally. During this process make sure that the **spring coils do not touch each other**, since this can cause **inadmissible high forces to build up**. The spring has to be fastened to the extent, that a slight but visible slit is left

between the coils. You can check this by sliding a piece of paper between the coils, as illustrated on the photo. If this is not possible, you fastened the knurled bolts too much and you have to loosen them. Also make sure that the cuplex does not rest on the cover of the barring mechanism of the socket, but on the core of the processor.

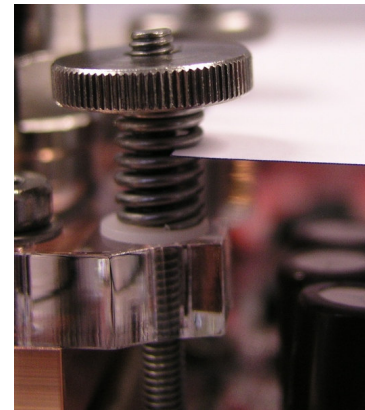

5.4. A64-mounting kit of the cuplex and cuplex evo

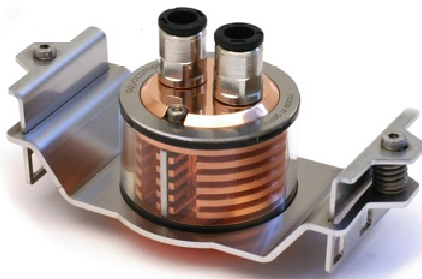

To make the installation of the cooler as simple as possible, taking into consideration the demanded high pressures, the basic principle of the 3-nose-mounting kit has been added by a mounting aid. First prepare the cooler by putting the supplied springs on the

threaded rivets in the mounting device of the cooler, then putting the angled metal sheets through the corresponding slits of the mounting device and pretightening the springs by fastening the supplied screws.

Now you can put the prepared cooler onto the processor, which should be covered with heat-conductive paste already, and effortlessly hook the mounting device into the black plastic frame of the mainboard. By alternately and evenly loosening the two screws the springs will be released and press the cooler onto the processor.

5.5. Combi-mounting kit four-hole and A64

The installation on mainboards with socket A and socket 478 is the same as the four-hole mounting kit (chapter 5.3. Installation with “four-hole mounting kit”). Use the four smaller springs in the screw set for it. For installation on mainboards for Athlon64 the cooler is also mounted analogous to the four-hole-mounting kit, but here only two screws are used, since there are just two holes for this purpose on the mainboard. Possibly an existing plastic frame has to be removed here, too, before fixing the screws. The two larger springs of the set have to be used here. The further process is described in chapter 5.3. Installation with “four-hole mounting kit”.

5.6. Examination and connection to the cooling system

Finally check again if the cooler rests plane on the core of the processor and does not touch the part of the socket in which the detachment mechanism is integrated.

WARNING: A cooler which does not rest plane on the core of the processor can cause destruction of the processor in seconds when the processor is switched on, since the heat-capacity of the core is too small. Even TCS, bios or software-shutdown-tools can not prevent destruction in this case!

Now cut the hoses evenly to the needed length with a hose cutter or a sharp knife and put them onto the connections of the cuplex. The procedure is described in chapter 4. Use of the plug&cool connectors.

5.7. Proper connection of the cuplex PRO

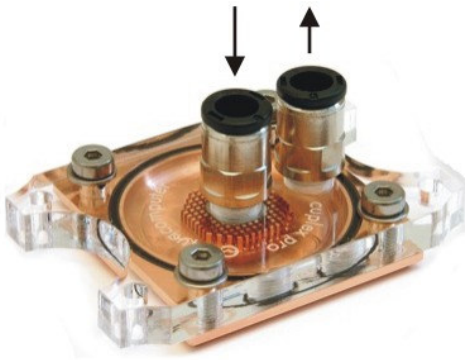

Differently from all other coolers of our range, the cuplex PRO has a set flowing direction. Since it is a nozzle-cooler, the water has to be lead over the connection in the middle directly to the nozzles, which “spray” the water into the cooler with high speed. Then the water is lead out through the connection on the side.

This way the cooler develops its complete performance, operating it reversely reduces the cooling performance clearly.

6. Thermo Control System (TCS)

Installation and connection into the green ATX-control line

The Thermo Control System prevents overheating of the CPU when there is a failure of the cooling system (defective pump, bent hoses, or the like), by turning of the ATX-power supply.

For that purpose the module is glued to the copper on the cuplex with heat conduction glue. On the cuplex evo however it is screwed onto the cooling body by using the supplied cap made of copper metal sheet and some heat-conductive paste. For this one of the screws on the cuplex evo is screwed off, the copper cap is slid over the supplied longer screw and bolted loosely with the supplied nut. Then the temperature sensor is screwed onto the cuplex evo with the cap.

The module will now be inserted into the power-switch-line. **Caution: to keep the warranty of the power supply unit you should use an extension cord for ATX-power supply units, which is sold separately by us.** Cut the power switch line (**green**) in the ATX-extension cord and connect each of the open ends with a flex of the TCS. For this special connectors are supplied to allow easy connection without soldering.

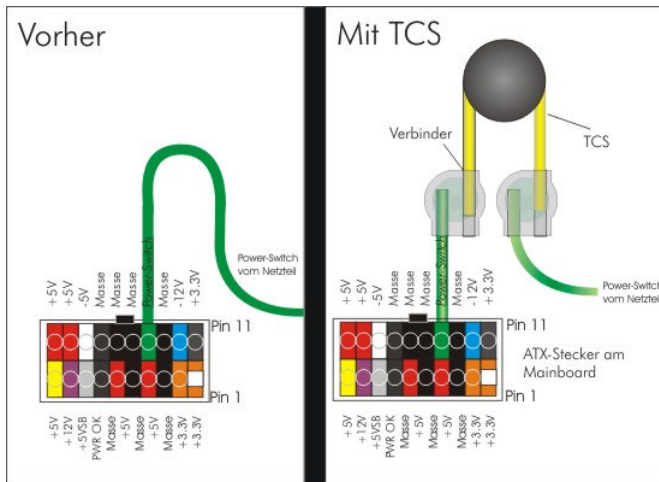

Just insert the cords to connect into the plastic connectors up to the stop and compress the connector. In operation the TCS can now cut off the power supply if the temperature of the CPU or the CPU-cooler is too high. This prevents destruction of the hardware quite effectively. Please note, that in this

case the operating system of your computer will not be shut down properly, which can cause loss of data. The TCS protects your valuable hardware in extreme situations, when software-solutions you possibly use should fail. It should only be used as the last link in the chain of security measures.

7. Installation of the chipset cooler twinplex™ for Northbridge or GPU

7.1. Versions with a stainless steel mounting plate

These coolers differ in mounting plates and lids, depending on the wanted version, but the mounting is identical.

First you have to take your motherboard or your graphics card out of the case, since the twinplex is screwed to the circuit board from behind.

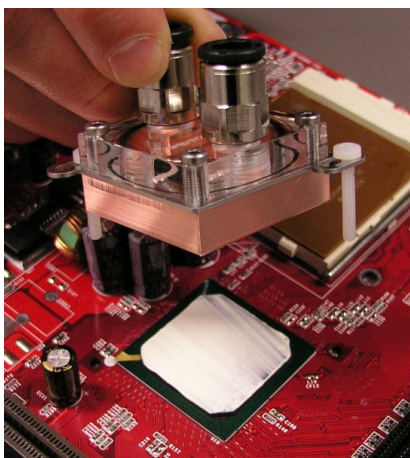

Remove the old chipset cooler. In most cases you just have to press two plastic dowels on the back of the circuit board together to allow them to be pushed through the holes. As on the CPU-cooler, you have to remove old heat-conductive paste and apply new paste, as described in the preceding chapter. Make sure that the heat-conductive paste is just applied to the real area of contact to the twinplex.

Now you can carefully put the twinplex onto the chipset. The holes of the stainless steel mounting plate have to be

aligned with the holes in the mainboard. Unlike with the cuplex, put one of the supplied nylon screws into the stainless steel mounting plate from above and slide one of the plastic washers on the screw from the back of the mainboard. Now screw one of the plastic nuts on the screw about 2 turns and repeat the procedure with the second screw. After both screws are loosely fixed you can begin tightening them. Carefully tighten the screws reciprocally with a screwdriver until the cooler can not be shifted on the chipset anymore. The stainless steel mounting plate must not be visibly bent. In this case the pressure is too high.

7.2. Twinplex for chipsets Intel® i845/i850/i875/E7205 and nForce®

Motherboards with these chipsets have eyelets instead of drilling holes to hook in a cooler. Mounting clamps are used here, which are hooked into the eyelets and which press the cooler onto the chipset with stainless steel springs.

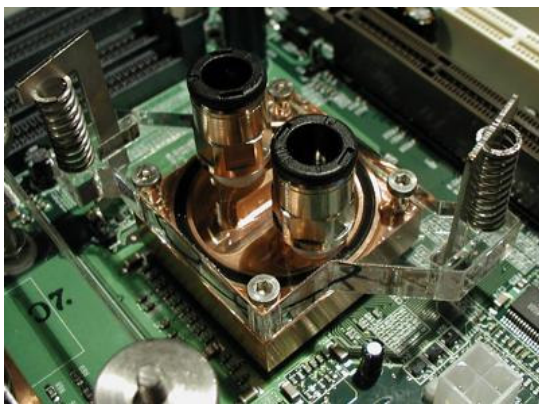

Here too, you have to remove the existing conventional chipset cooler. A thin layer of heat-conductive paste is applied onto the chipset after old remaining heat-conductive paste has been removed. The mounting clamps have to be inserted into the slits of the lid with the spring holder showing away from the cooler. Then the

springs are inserted between clamp and Plexiglas lid, as shown on the picture. The twinplex is now carefully put onto the chipset, so the noses of the Plexiglas lid are situated above the mounting eyelets of the motherboard, and the mounting clamps are hooked into the eyelets. To be able to adjust the pressure, the clamps have a three-level profile.

7.3. Twinplex for Radeon® 9500 - 9800XT

The twinplex for the use with the ATI® Radeon® 9500 and higher has a special bottom, since the GPU on the chip has a premounted spacer. But the installation is the same as in chapter 7.1. Versions with a stainless steel mounting plate.

7.4. Examination and connection to the cooling system

Finally check the correct fitting and install the hoses, as described in chapter 4. Use of the plug&cool connectors. Remember not to install water coolers parallel.

8. Installation of the harddrive coolers aquadrive™, aquadrive LT and aquadrive micro

8.1. aquadrive

The hard drive cooler aquadrive is intended for installation in a 5¼" drive shaft and accommodates a 3½" harddrive. Before you start the mounting check the positions of the jumpers on the harddrive and correct them if necessary. If you don't have a data-sheet for your harddrive, you should write down the jumper settings and the position of pin 1 of the IDE-connection, so you don't have to disassemble the aquadrive completely on later conversions on your hardware.

To install the harddrive the stainless steel plate on the back has to be removed. Also the screws that fix the side elements to the engraved front plate have to be loosened a little to be able to optimally adjust the side elements to the width of the hard drive. Now the hard drive is slid into the aquadrive from the back until at least two threads can be seen through the holes in the side elements on both sides. After screwing the hard drive to the side elements, you can screw on the front and the back mounting plate firmly. Now screw the plug&cool connectors into the designated threads on the back side. Then put two of the four rubber buffers into the matching holes on each side. From the four holes on each side choose the ones that suit your case best. Mounting in the CS-rail design is possible too. Finally slide the completely assembled aquadrive into the drive shaft and fasten it with the supplied screws (consider the manual to your case). The connection to the motherboard and to the power supply system is made through the gap in the back plate.

More information and photos regarding the installation of the aquadrive can be found on our website www.aqua-computer.de in the forum

("water cooling", theme "Photo story! Pictures of mounting all AC-components").

8.2. aquadrive LT

The hard drive cooler aquadrive LT is a version of the aquadrive that is reduced to a pure cooling function. It allows the installation of a water cooled 3½" harddrive in a 5¼" drive shaft. It is supplied unmounted to prevent damages caused by transport. First install the supplied Plexiglas tube into one of the side elements, by turning the tube with slight pressure. Then install the harddrive you want to be cooled to that side element with common screws, before sliding the second side element onto the Plexiglas tube with a turning motion. If you have problems mounting the Plexiglas tube you can use a drop of glycerine as lubricant. Now fasten the hard drive to the second side element and put the four supplied rubber buffers into the matching holes on the sides of the cooling bodies. Finally fasten the complete cooler with the harddrive in you PC-case. Matching screws are supplied with the cooler.

8.3. aquadrive micro

The harddrive cooler aquadrive micro allows cooling of a 3½" hard drive in a 3½" harddrive cage (provided that there is sufficient height). For this the cooler is fastened under the hard drive with common screws. As usual the harddrive is mounted to the cooler with the threads on the sides of the harddrive.

8.4. Examination and connection to the cooling system

Finally check the correct fitting and install the hoses, as described in chapter 4. Use of the plug&cool connectors. Remember not to install water coolers parallel.

9. Installation of the water cooler power supply units

9.1. CoolCurrent

The water cooled ATX-power supply unit **CoolCurrent** is inserted into the cooling circuit as described in chapter „plug&cool“.

10. Installation of the radiator airplex evo 120/240/360

The purpose of the radiator is to give off the absorbed heat of the components of the system to the surrounding air. To enable this, a sufficient amount of air has to flow through the radiator. Therefore, to achieve sufficient performance, the airplex evo has to have **sufficient space**. There should be space of at least 2 cm between its bottom and the next surface. There should be space of not less than 20 cm above its surface. If the airplex evo is installed inside a computer, an active air stream has to be created by a fan. If the airplex evo is standing freely, for example in the external mounting device we offer, you can do without the use of fans in most systems. But you should consider that no very low CPU-temperatures can be obtained this way. An exact statement from how many watts performance lost an active air stream is necessary can't be made, since this depends on the desired CPU-temperature, the installation of the airplex evo and on further surrounding factors. If you choose a passive operation of the heat changer you should secure, with a suitable tool, that the temperatures reached are acceptable even under full load. Optimally developed for that purpose is the aquaero™ as a complete monitoring and diagnosis hardware. As mentioned above, software tools can be found on www.aqua-computer.de in the support area under „Downloads“.

The airplex evo should be installed horizontally, but it can also be installed vertically.

10.1. Installation of the connectors

Before installing the airplex evo the connectors have to be screwed into the designated threads. **Please make sure that the thread bushing on the radiator will not be twisted**, since this can damage the radiator. Generally the connectors should be screwed in by hand without much force.

10.2. External mounting kit

When using the **external mounting kit for airplex evo 240/360**, which is included in some of the sets, the two brushed high-grade stainless steel

cases are attached to the radiator with the supplied screws. Use the two outer threads on the radiator for this.

10.3. Internal installation with fitted mounting plate

For the **internal installation** of the airplex evo you additionally need a suitable mounting plate in the corresponding size, which is available separately. In some of the sets this mounting plate is included already. Also you should make sure that there is sufficient space available for an installation and drive shafts which are possibly blocked by the radiator are dispensable. You will also find suggestions for the installation of the airplex evo in our forum, especially in our „Photo stories“.

First a suitable opening has to be sawed into the cover or the side of the case. A stencil for marking on the case can be found on the package of the mounting plate. The mounting plate is now screwed onto the ready opening, using the four outer drilling holes. The airplex evo is fastened below this, by bolting screws through the fitted mounting plate into the thread bushings of the airplex evo. Depending on the desired size of the airplex evo 1-3 120mm fans (separately available) can alternatively be installed between the airplex evo and the mounting plate. For that purpose use the longer of the supplied screws, push it through the fitted mounting plate, slide the fans over the screws and fasten the airplex evo below the fans. See to it, that the air stream will flow through the fans in the right direction. Generally it is useful to carry out the warm air from the computer case, but in some cases (depending on the other circulation of air inside the computer case) the opposite can be useful. **Caution: if you do not install any fans, you must use the shorter screws, since the airplex evo could be damaged by screws reaching into the radiator! Also, if you do not use active cooling of the airplex evo and install it into the case, you have to monitor the system temperature and add fans if the temperatures get too high!**

10.4. Internal installation with CS-fitted mounting plate for airplex evo 120

For the combination of airplex evo 120 and a Chieftech Bigtower case (CS-901/2001/3001) we offer a special brushed high-grade stainless steel mounting plate which substitutes the standard power supply unit

mounting plate on the back of the case. The big advantage of this mounting plate is that you don't have to saw an opening into the computer case. First you have to remove the original mounting plate and the mounting plate for the power supply unit and fit it into the opening of our brushed high-grade stainless steel mounting plate. On it you can fasten the power supply unit and the airplex evo 120 with the 120mm fan now using the supplied screws. Since the airplex evo is installed vertically here, it should definitely have an active cooling by a fan.

10.5. Connection to the cooling system

Finally the airplex evo is inserted into the cooling circuit as described in chapter „plug&cool“.

10.6. Use of the docking module for the airplex evo

By means of the airplex evo docking module you are able to stack several radiators on top of the other to increase the heat changing performance. To decide if an existing airplex evo is not able to carry off enough heat, you should use the tools already mentioned to monitor the system temperature. You will find them on our website www.aquacomputer.de in the support area under „Downloads“.

First mount the two bent high-grade stainless steel sheets on the first of the radiators to be connected. Then place the second airplex evo **between** the brushed high-grade stainless steel sheets (it will be gripped by the brushed high-grade stainless steel sheets), the thread bushings facing up. From here on the mounting is the same as the mounting of a single airplex evo under a fitted mounting plate. The screws are slid through the brushed high-grade stainless steel mounting plate, through the fan and drilling holes in the brushed high-grade stainless steel sheets if necessary, and screwed into the thread bushings of the upper airplex evo.

11. Installation of the pumps

11.1 Installation of the pumps Eheim 1046 and 1048

There is a separate manual by the Eheim company supplied with the pump. Please read it first and consider the advices given in it. The pump

is supplied with connection adapters for the plug&cool system in the sets we offer. Screw these adapters into the matching openings of the pump (without the use of any tools to prevent damages to the pump casing). The connectors should only be fastened by hand. If you don't use a reservoir, just connect the hose to the pressure side for now (on the upper side of the pump, similar to the picture), since you will use the pump as a submersible pump to fill up the system. When using the reservoir type aquainlet™, the suction sided adapter is not used, but the reservoir is mounted directly on the suction side (look at „Installation of a reservoir“). If you are using the aquatube, connect the suction side of the pump directly with the down facing connection of the reservoir. Make sure that the case of the pump is completely tight.

Since the pump includes a synchronous motor, it generates a magnetic field as any electromagnetic motor. Also there is a rather powerful permanent magnet inside the pump. This magnet rotates and creates a changing magnetic field, too. **For this reason keep a safety distance of at least 0.5 m to all sensible devices, as hard drives, magnetic data media, screens and so on.** To shield this electromagnetic field you can also install the pump in a shielded case which is available separately.

11.2. Installation of the pump Hydor L20



This pump is supplied with a separate manual of the manufacturer, too. Please read it first and consider the advices given in it. In our AC-entry-set the pump is supplied with connection adapters for the plug&cool system. Screw these adapters into the matching openings of the pump now, without the use of any tools. The connectors should only be fastened by hand. If you don't use a reservoir, just connect the hose to the pressure side for now (on the upper side of the pump, similar to the picture), since you will use the pump as a submersible pump to fill up the system. If you are using the aquatube, connect the suction side of the pump directly with the down facing connection of the reservoir. Make sure that the case of the pump is completely tight.

Since the pump includes a synchronous motor, it generates a magnetic field as any electromagnetic motor. Also there is a rather powerful permanent magnet inside the pump. This magnet rotates and creates a changing magnetic field, too. **For this reason keep a safety distance of at least 0.5 m to all sensible devices, as hard drives, magnetic data media, screens and so on.**

12. Installation of a water reservoir

A reservoir is used to collect any air that should be in the system. More than this it offers the comfortable opportunity to fill up the completely assembled system, since diving of the pump is dispensable when filling the system over the reservoir. Also coolant additives like ACfluid, BlueMotion or GlowMotion can be added simply later this way. To use the reservoir for filling, naturally it has to be the highest part of the system (at least until the ready filled system is closed tightly). The water cycle has to be closed completely (including the pump). The system is filled up through the open lid of the reservoir.

12.1. Water reservoir of the type aquatube

First you have to install the supplied connectors and close the remaining free connector holes with the four supplied blind plug. Generally you can install the connectors on any of the holes, but you should consider the following advices:

- The connection from which the coolant is sucked out of the reservoir should be as low as possible. It depends on the way of installation of the aquatube (lying/standing) which opening you should use.
- The connection through which the water flows back into the reservoir can be chosen freely. But if you use the cleaning device **aquajet™**, which is available separately, you have to install it at the middle opening on the bottom of the aquatube.
- The remaining free holes are closed with the supplied blind plug or alternatively with separately available illumination modules (see below).

Generally the aquatube can be put loosely standing on any place on or inside the case. To make the system ready for transport the aquatube should be fastened using the existing threads on top and below the case. The matching screws in M4 are supplied with it. Probably the most elegant method optically is the installation in the side of the case on the brushed high-grade stainless steel mounting plate, which is optionally available. A stencil for sawing a suitable opening into the side of the case can be found on the package of the fitted mounting plate. Also the points for the drilling holes for fastening the mounting plate in the case are marked on it. But these can be marked by using the holes in the mounting plate, too. As soon as the opening for the aquatube and the drilling holes in the case are ready you can screw the mounting plate into the case and fasten the aquatube below (alternatively above) the mounting plate.

Our **aquabay™** allows a horizontal installation in the drive shafts without sawing. For this, install the aquatube on the supplied front mounting plate which is bolted with the u-shaped mounting plate. Then the aquabay is fastened into two 5¼" drive shafts. Please consider the manual of your case for this. Also mounting on the CS-rail design is possible.

Further suggestions for the installation of the aquatube you will find in our forum, especially in our „Photo stories“.

Optionally there is an **illumination module** available for the aquatube which is screwed tightly into a free thread of the aquatube with a supplied gasket. It substitutes the normal blind plug. The power connection for the LED is provided by a common 5¼" power supply plug through the power supply unit. The LED can be fastened with a drop of glue.

12.2. Water reservoir of the type aquainlet

The reservoir aquainlet is no independent part in the cooling cycle like the aquatube, but is an addition to the pump (exclusively compatible to **aquastream™**, Eheim 1046 and 1048). The installation is even easier as with the aquatube, since the aquainlet just has to be plugged onto the suction side of the Eheim. Make sure that the gaskets in the opening for the suction side of the pump fit well and that you slide the reservoir onto the suction side up to the end. To ease the installation you can moisten the gaskets of the aquainlet or rub a drop of glycerine on it.

As well as the aquatube, the transparent version of the aquainlet has a possibility for an illumination module to be installed. The installation is made by simply plugging the LED in or gluing it into the intended opening.

13. Putting the system into operation

At last fill up your system with a mixture of 98% of distilled water (available in DIY- and supermarkets as well as on gas stations) and 2% of ACfluid.

If your system disposes of a reservoir you can fill up your system considering the advices mentioned above. In this case, depending on the components used, you will need about 200-600 ml of coolant.

Should you build your system without reservoir, you will need a bucket with a capacity of about 5 litres to fill it up. Put your diving pump, **which is not connected to the power supply system yet**, into the bucket (suction side is connected to the cooling cycle). Then fill the bucket with the coolant until the pump is completely under water. Take the hose into your hand that will lead from the cooling cycle directly to the still open suction side of the pump later and hold it into the bucket.

Caution: make sure again that your wall socket is protected by an FI-fuse and the used pump is suitable for diving operation!

If this is the case you can put the pump into operation. Now the water begins to flow through the cooling cycle and through the hose in your hand back into the bucket. Now swing the radiator back and forth a couple of times to get larger amounts of air out of the system. When the water flows back into the bucket without bubbles, you can plug the hose on the suction side of the pump under water. Should you hear loud noises from the pump after closing the connection, this is a sign for air remained inside the case of the pump.

In this case you should repeat the process of filling up the system until no noticeable amount of air is left inside the system. **Naturally the computer has to be switched off during the whole process of filling up the system.**

When you deaerated your system sufficiently, dry the pump thoroughly.

CAUTION: Finally the whole system has to be checked for possible leaks.

The system is now ready for operation.

After a run in time of about 10 hours of operation or when there is visible pollution, we advise you to change the coolant again to remove pollution and possible residue of production (e.g. oils and filings) from the system. On this occasion open the case of the pump, too, to remove possible pollution. For this follow the instructions given in the separate manual of the pump.

14. Maintenance and care instructions

Regularly check the system on possible leaks and observe the water level. If you use the coolant we specified, it is sufficient to exchange it once a year. Since our sets are exclusively closed cooling circuits, an intrusion of air oxygen is not to be expected. This is why the possibility of a biological pollution is very small.

You can check the condition of the coolant through the Plexiglas lids of the coolers and in the reservoir. If there is any pollution you should exchange the cooling medium.

In operation the pump is maintenance free. But it should be dismantled and cleaned on each exchange of water (please read the manual of the pump for this). All the gaskets in the system have to be exchanged if they are visibly worn out, after 5 years at the latest. You can get single gaskets from us or let us do the exchange. Also check the hoses for changes in material regularly. Should they get brittle or have scratches you should exchange them.

The copper of our coolers is natural. It will create a layer of oxide in time. This protects the copper from further corrosion. The normal oxidation creates a red layer of oxide which looks very good. On places the copper got into contact with sweat, it will create a black layer of oxide. Since this doesn't look so good, you can easily remove this layer with a suitable copper polish. Make sure that the polish you use does not include any abrasives, since this will damage the surface of the copper. Also make sure that the Plexiglas components will not get into contact with the polish.

Care instructions for all Plexiglas components:

Never use solvents (e.g. alcohol, methylated spirit) to clean the Plexiglas parts! Solvents damage the Plexiglas and can cause tears or breaks in the Plexiglas. If a Plexiglas component should get into contact with a solvent, you should absolutely exchange it to keep the operation safety of the cooler. Damages caused by solvents may become visible some time after the contact. Suitable spare parts are available from us.

After you read this manual completely, we wish you a successful installation of your water cooling system and hope you will enjoy our products. If you do have any more questions we will be happy to help you per e-mail or in our support-forum.

